



BELIEVE INDUSTRY

ADD No 1, Yudong Road, Huishan District, Wuxi, China

TEL +86 186 1692 7760 +86 173 5168 0080

EMAIL enquiry@believeindustry.com

enquiry@belirollforming.com

WEB believeindustry.com

belirollforming.com

ROLL FORMING MACHINERY

BELIEVE INDUSTRY

ROLL FORMING

*Precision Engineering & Manufacturing
Cold Roll Forming Solutions*

ABOUT US

WHO WE ARE

Believe Industry is a specialized manufacturer of cold roll forming machinery, headquartered in Wuxi, Jiangsu Province, China — a region renowned for advanced industrial manufacturing. With decades of accumulated engineering expertise, we design, manufacture, and export complete roll forming production lines for clients across the globe. Our commitment to precision engineering and dependable after-sales support has earned us lasting partnerships in over 50 countries.

From steel structure profiles and solar mounting systems to storage rack solutions and custom metal sections, Believe Industry delivers turnkey roll forming lines that combine robust construction with intelligent control. Every machine undergoes rigorous pre-delivery testing to ensure reliable performance from day one. Our customer base spans Australia, the Americas, Europe, the Middle East, Southeast Asia, and Africa — a testament to the quality and value we consistently provide.

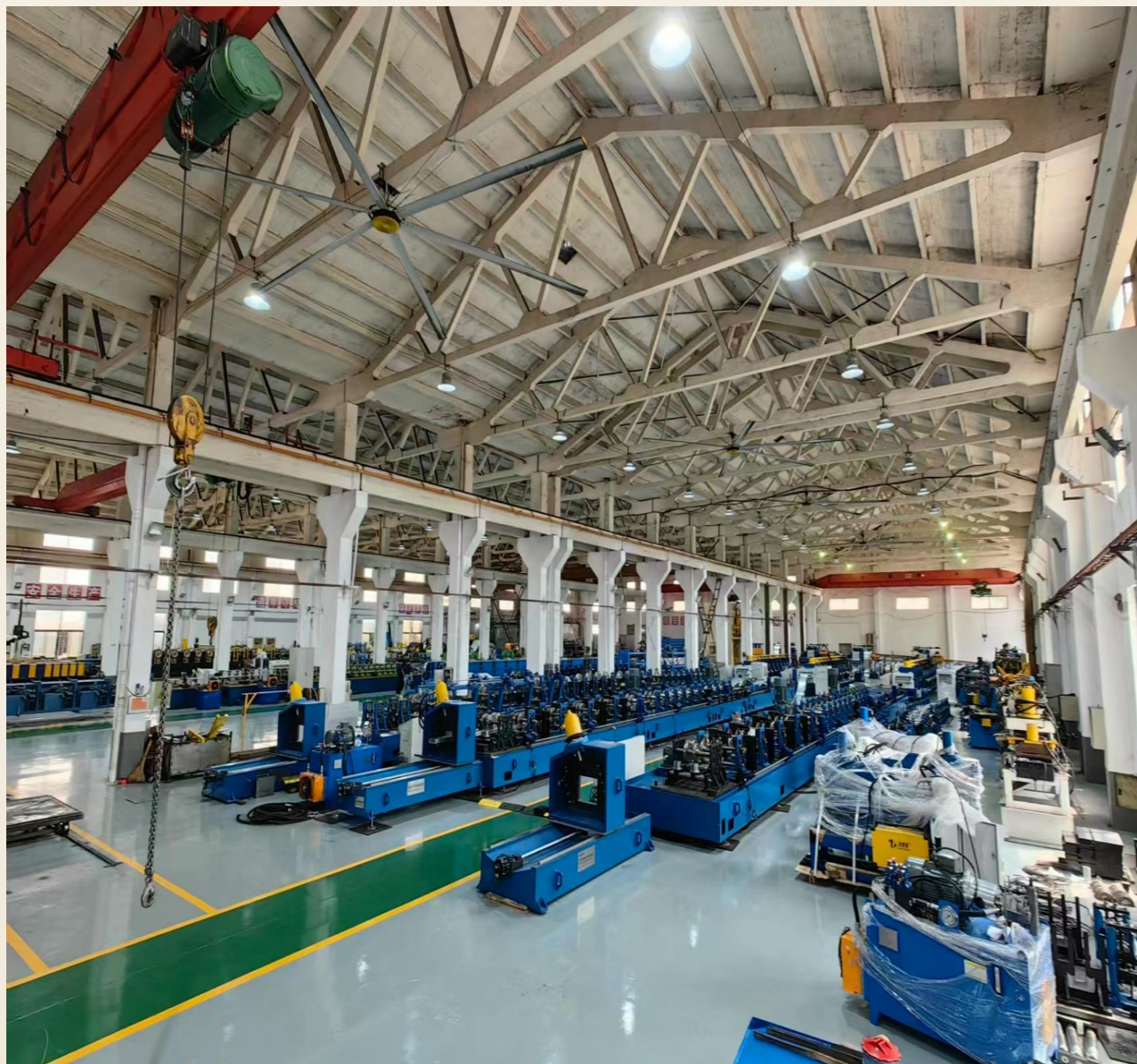

OUR PURPOSE

WHAT DRIVES US

OUR MISSION

To empower manufacturers worldwide with precision-engineered roll forming solutions that deliver exceptional quality, reliable performance, and lasting value. We are committed to advancing the cold roll forming industry through continuous innovation and dedicated customer partnership.

01

PRECISION

Advanced CNC machining, globally sourced key components, and rigorous pre-delivery testing on every machine.

02

INNOVATION

Senior mechanical and electrical engineers continuously refine roll forming processes for optimal performance.

03

GLOBAL SERVICE

Service network spanning 50+ countries with remote diagnostics, online training, and on-site installation support.

04

PARTNERSHIP

Built on integrity and trust, we cultivate long-term client relationships through transparent collaboration.

15+
YEARS

50+
COUNTRIES

200+
LINES DELIVERED

100%
TESTED

目录 CONTENTS

彩钢板系列设备 Color steel plate series equipment

波纹板成型机 Corrugated sheet roll forming machine	01
瓦楞板成型机 Wall panel roll forming machine	01
双层彩钢板成型机 Double deck roll forming machine	02
楼承板成型机 Floor Deck roll forming machine	02
琉璃瓦成型机 Glazed Tile Roll forming machine	03
屋脊瓦成型机 Roof Ridge cap roll forming machine	03
落水管成型机 Downpipe roll forming machine	04
圆形落水管成型机 Round downpipe roll forming machine	04
水槽压型机 Rain gutter roll forming machine	05
屋面吊顶扣板机 Roofing ceiling roll forming machine	05

门窗系列设备 Door and window series equipment

门框冷弯成型生产线 Door frame roll forming machine	06
卷帘门叶片冷弯成型机 Rolling shutter roll forming machine	06
窗框冷弯成型生产线 Window frame roll forming machine	07
门轨冷弯成型机 Door rail roll forming machine	07

仓储货架系列设备 Storage shelf logistics equipment

货架冷弯成型生产线 Shelf/Rack roll forming machine	08
货架承板冷弯成型生产线 Shelf/Rack panel roll forming machine	08
合抱梁冷弯成型机(咬合) C box beam forming machine	09
P型梁冷弯成型机(焊接和咬合) Step beam forming machine	09

冷弯型钢系列设备 Cold roll forming eries equipment

C/Z 互换型钢机(齿轮箱传动) C/Z purlin roll forming machine(gear box drive)	10
C/Z 互换成型机(跟踪剪切) C/Z purlin roll forming machine(flying cutting)	10

护栏板成型机 Guard rail roll forming machine	11
脚踏板成型 Scaffolding roll forming machine	12
桃型立柱成型机 Peach post roll forming machine	12
三角支架成型机 Triangular bracket roll forming machine	13
葡萄架成型机 vineyard post roll forming machine	13
型钢成型机 Steel roll forming machine	14
行车KBK轨道 Bridge crane KBK track roll forming machine	14
角钢成型机 Angle roll forming machine	15
轻钢龙骨压型机 Stud-Track roll forming machine	15
太阳能光伏支架成型机 Solar photovoltaic bracket forming machine	16
刀片成型机 Blade roll forming machine	16

车辆型材系列设备 Vehicle series equipment

澳大利亚房车封板 Australia RV carriage board roll forming machine	17
火车车厢板成型机 Train carriage board roll forming machine	17
美国通用皮卡底盘加强筋冷弯成型生产线 U.S.A Universal pickup chassis stiffener roll forming machine	18
德国宝马玻璃升降器冷弯成型机 German BMW window regulator roll forming machine	18

电缆桥架系列设备 Cable tray series equipment

核岛桥架 Nuclear island cable tray roll forming machine	19
澳洲桥架 Australia cable tray roll forming machine	21
阿根廷桥架 Argentina cable tray roll forming machine	23
俄罗斯桥架 Russia cable tray roll forming machine	25
桥架梯边成型机 Cable tray ladder side roll forming machine	27
桥架横梁成型机 Cable tray beam roll forming machine	28

纵横剪系列 Slitting & cutting series equipment

简易纵、横剪生产线 (0.3~1.5mm)Simple slitting & cutting line	29
高速纵剪生产线 High speed slitting line	31
高速横剪生产线 High speed Cut to length line	33

彩钢板系列设备 Color steel plate series equipment

波纹板成型机
Corrugated sheet roll forming machine

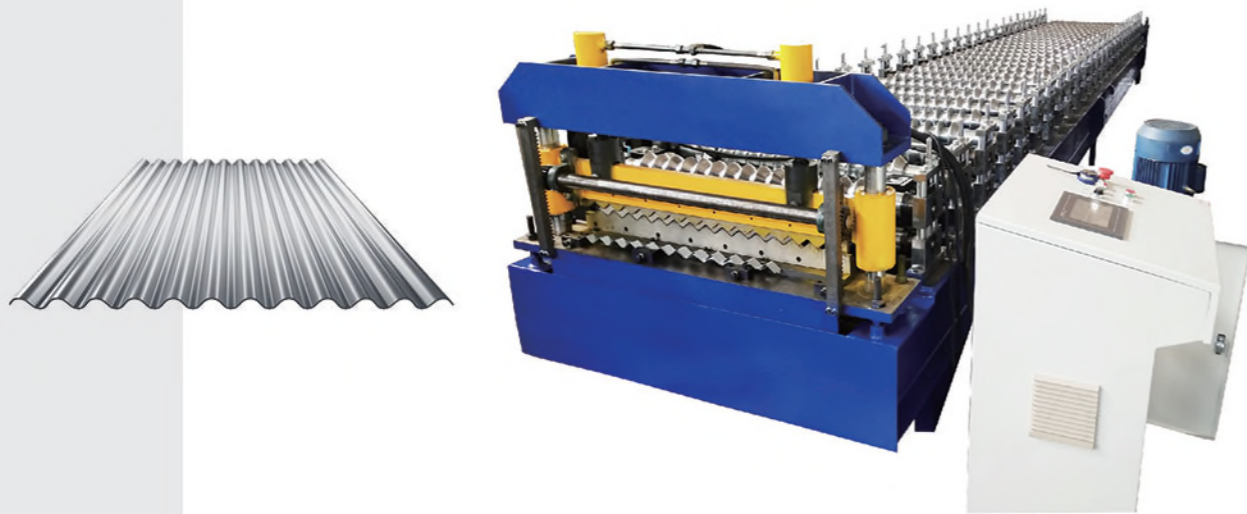

双层彩钢板成型机
Double deck roll forming machine



自动码垛 Automatic stack

瓦楞板成型机
Wall panel roll forming machine

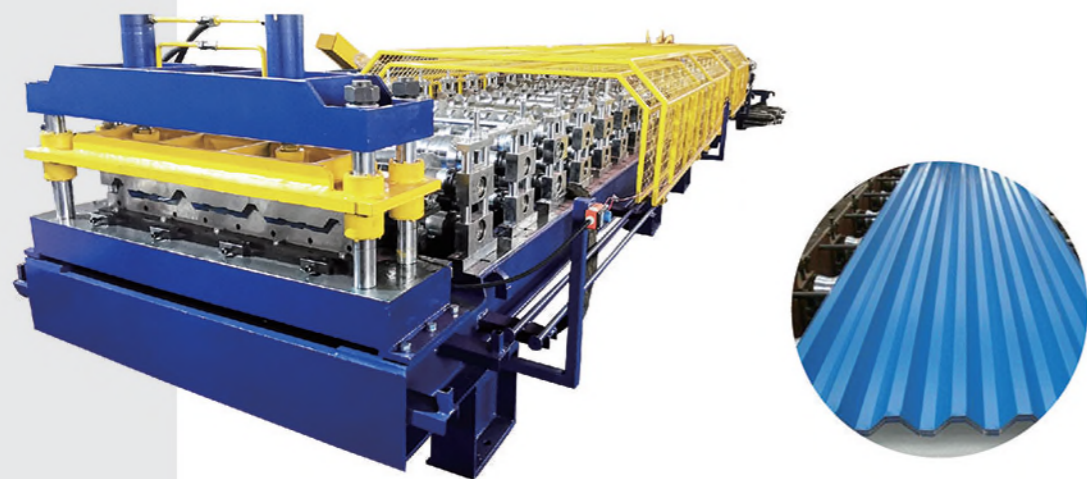

楼承板成型机
Floor Deck roll forming machine

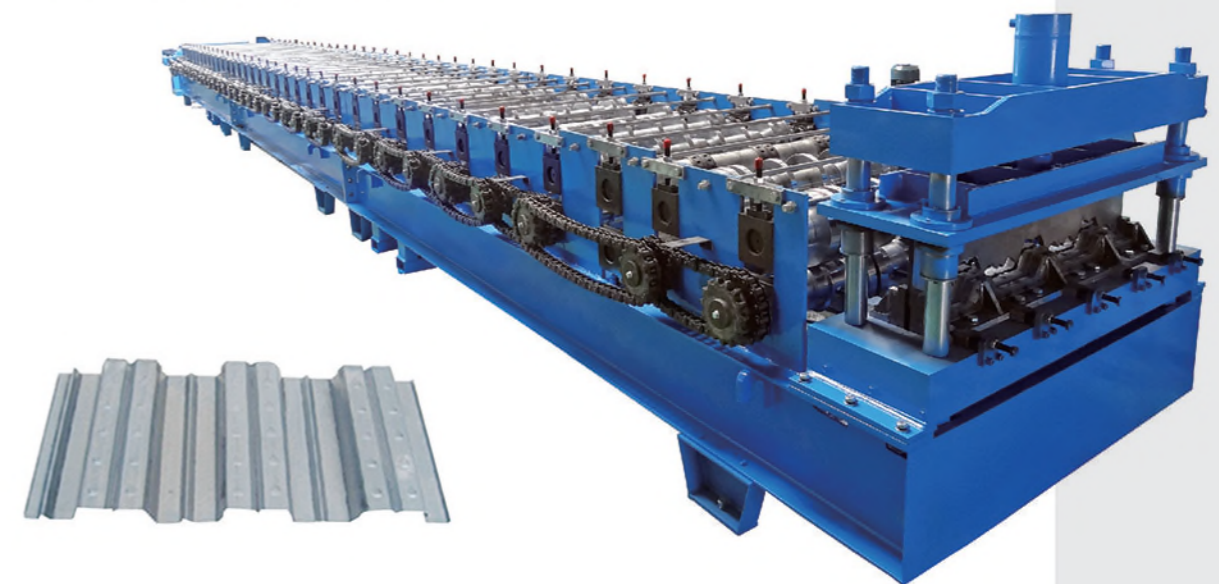

01

Integrity
Enterprising
Cooperation
Innovation

02

Integrity
Enterprising
Cooperation
Innovation

琉璃瓦成型机

Glazed Tile Roll forming machine

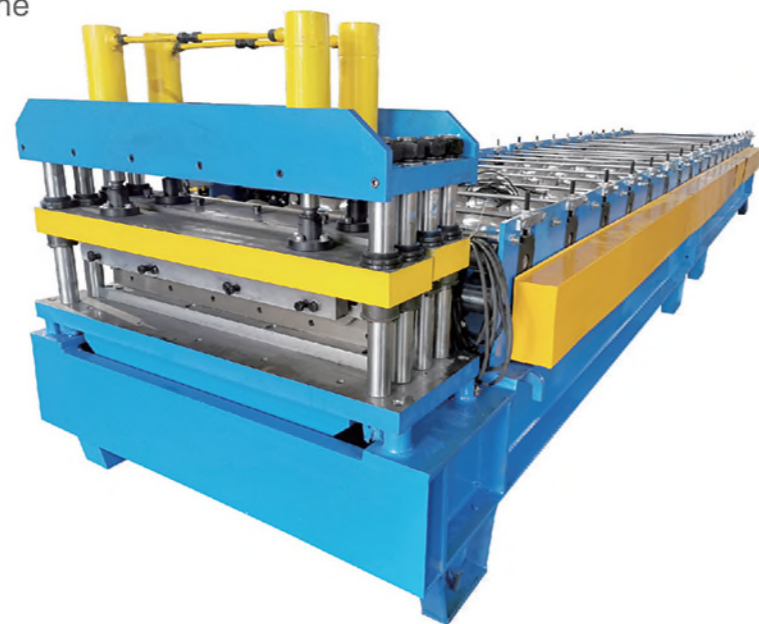
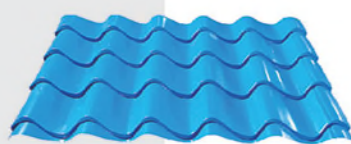

落水管成型机

Downpipe roll forming machine



圆形落水管成型机

Round downpipe roll forming machine

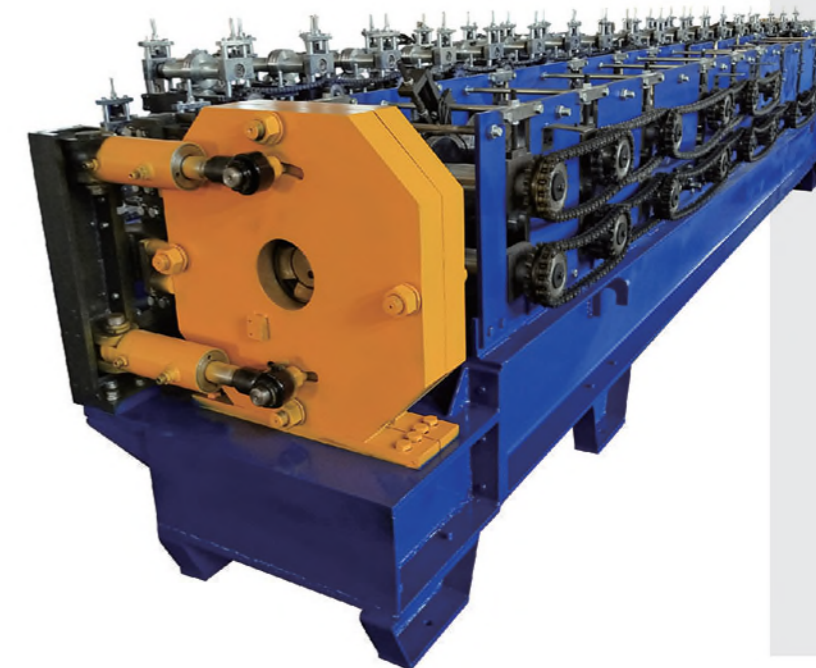

屋脊瓦成型机

Roof Ridge cap roll forming machine

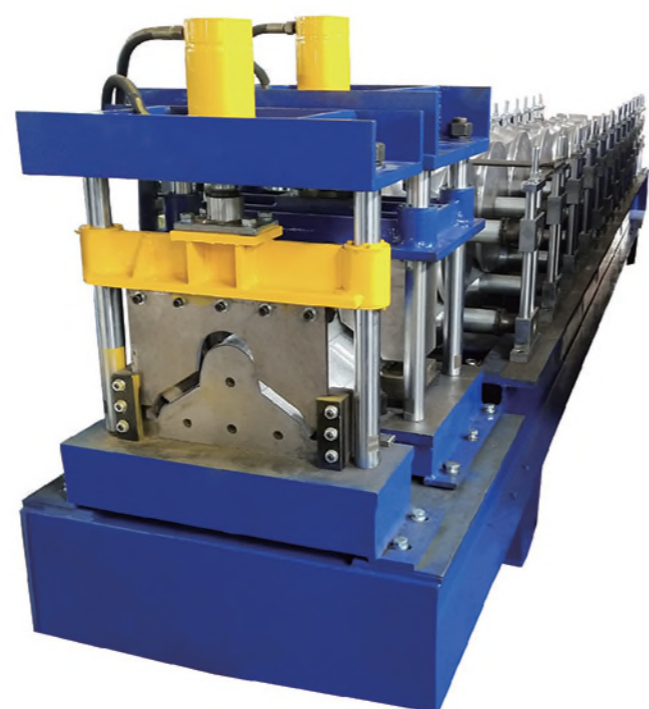
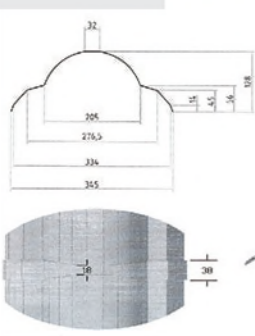

水槽压型机
Rain gutter roll forming machine

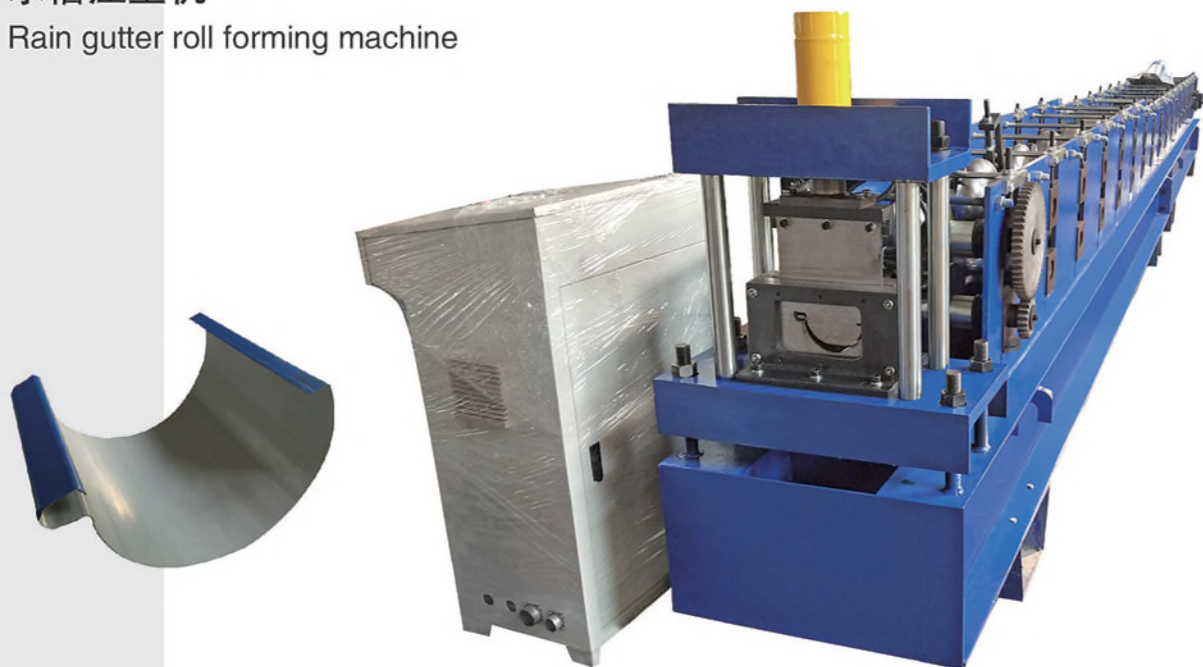

屋面吊顶扣板机
Roofing ceiling roll forming machine

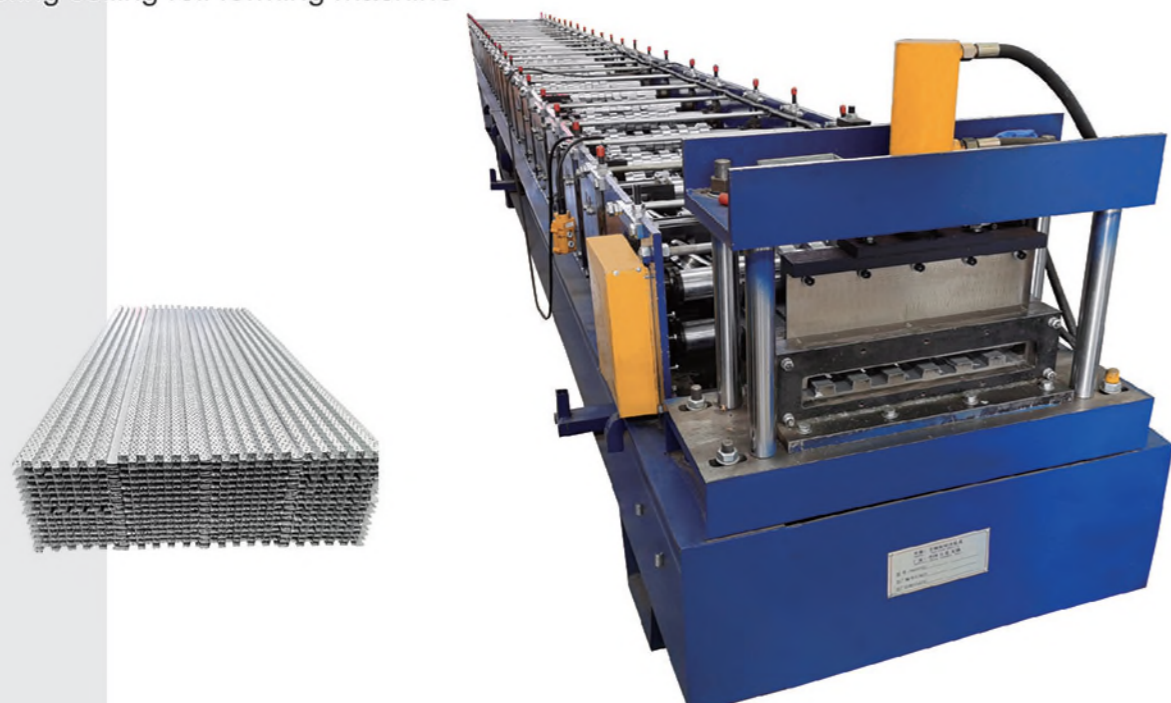

门窗系列设备 Door and window series equipment

门框冷弯成型生产线
Door frame roll forming machine



卷帘门叶片冷弯成型机
Rolling shutter roll forming machine



窗框冷弯成型生产线
Window frame roll forming machine



仓储货架系列设备 Storage shelf logistics equipment

货架冷弯成型生产线
Shelf/Rack roll forming machine

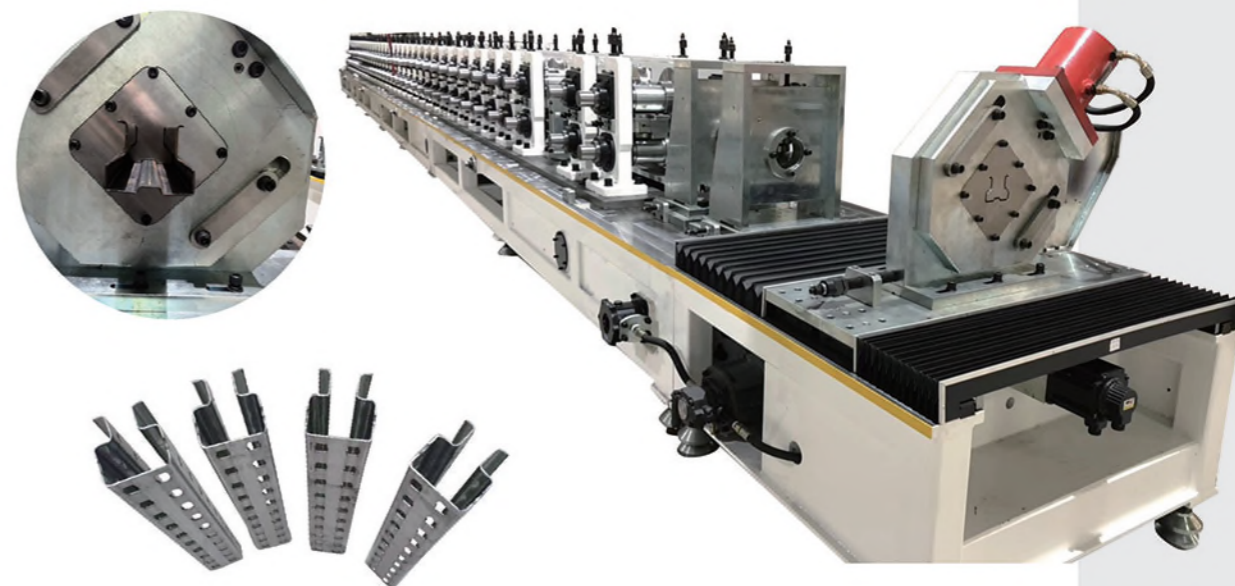

货架承板冷弯成型生产线
Shelf/Rack panel roll forming machine

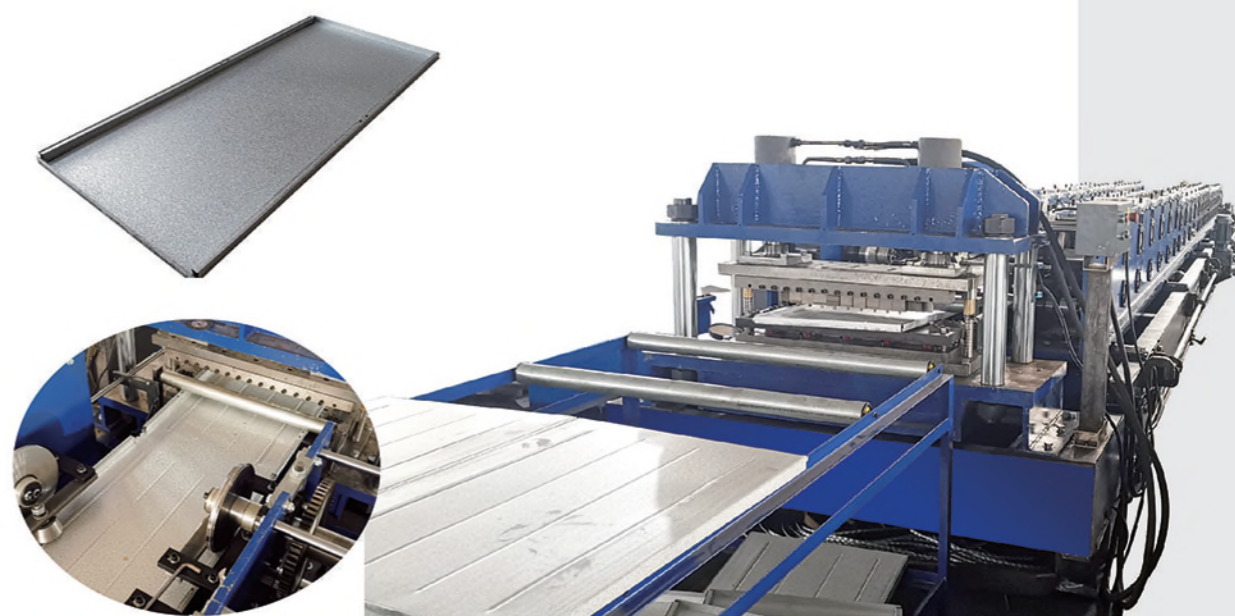

门轨冷弯成型机
Door rail roll forming machine

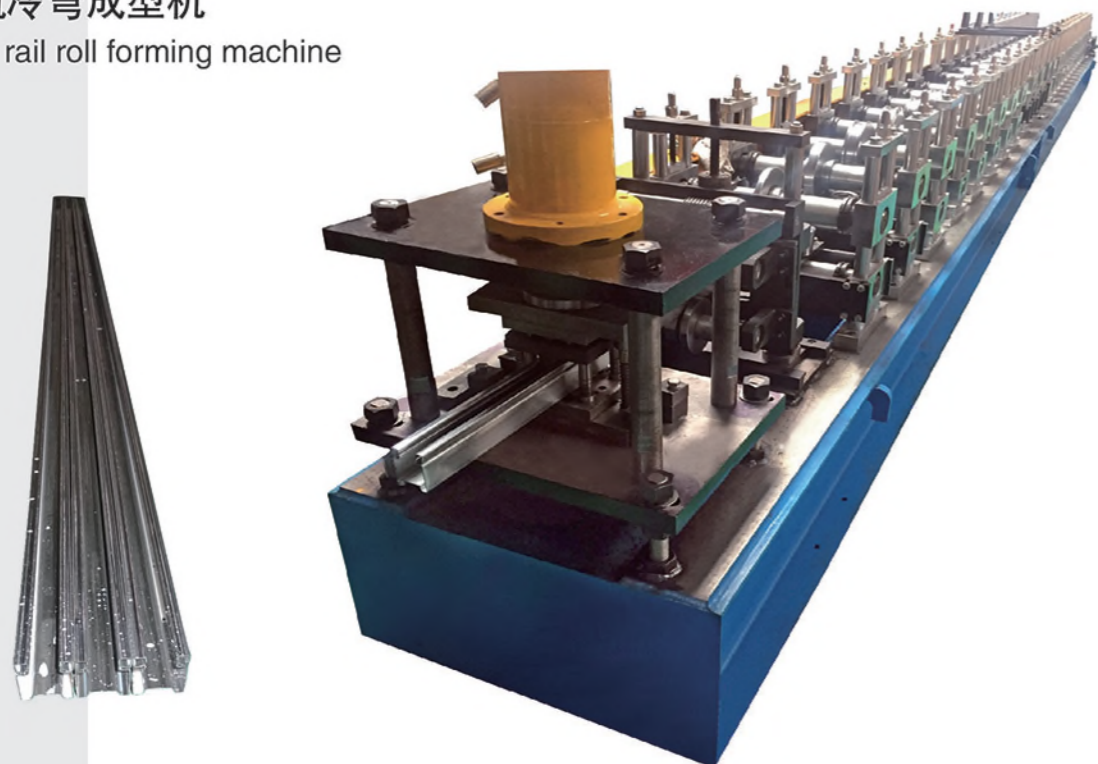

合抱梁冷弯成型机(咬合)
C box beam forming machine



冷弯型钢系列设备 Cold roll forming eries equipment

C/Z 互换型钢机(齿轮箱传动)
C/Z purlin roll forming machine(gear box drive)

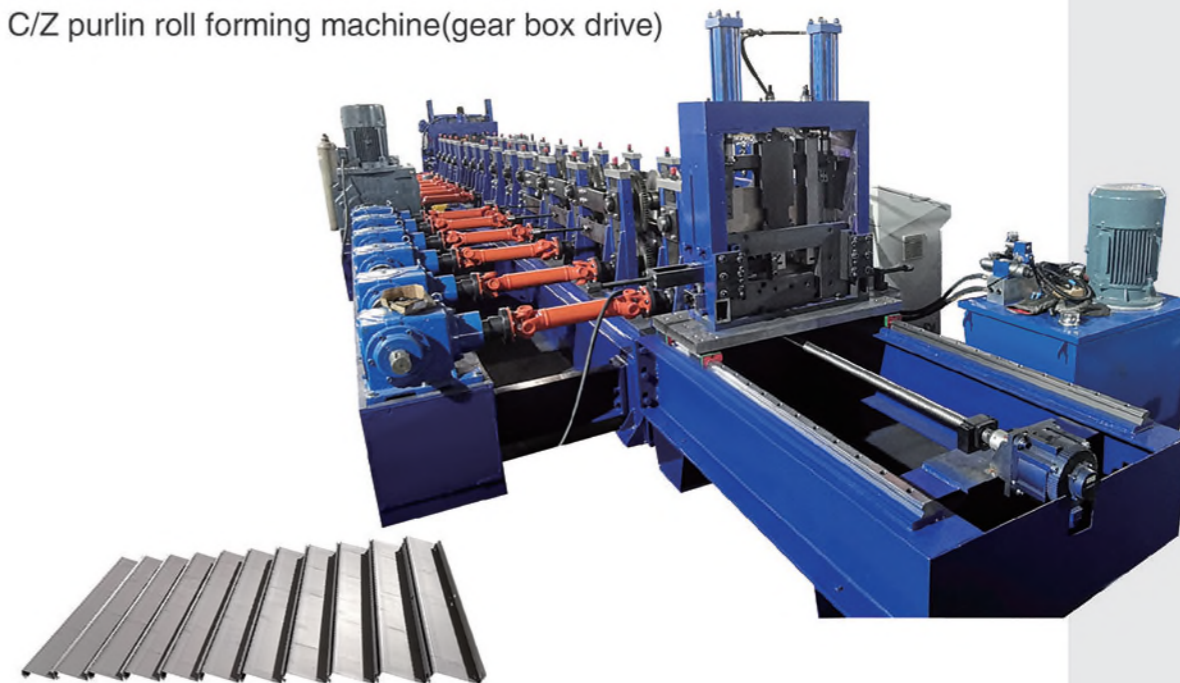

P型梁冷弯成型机(焊接和咬合)
Step beam forming machine

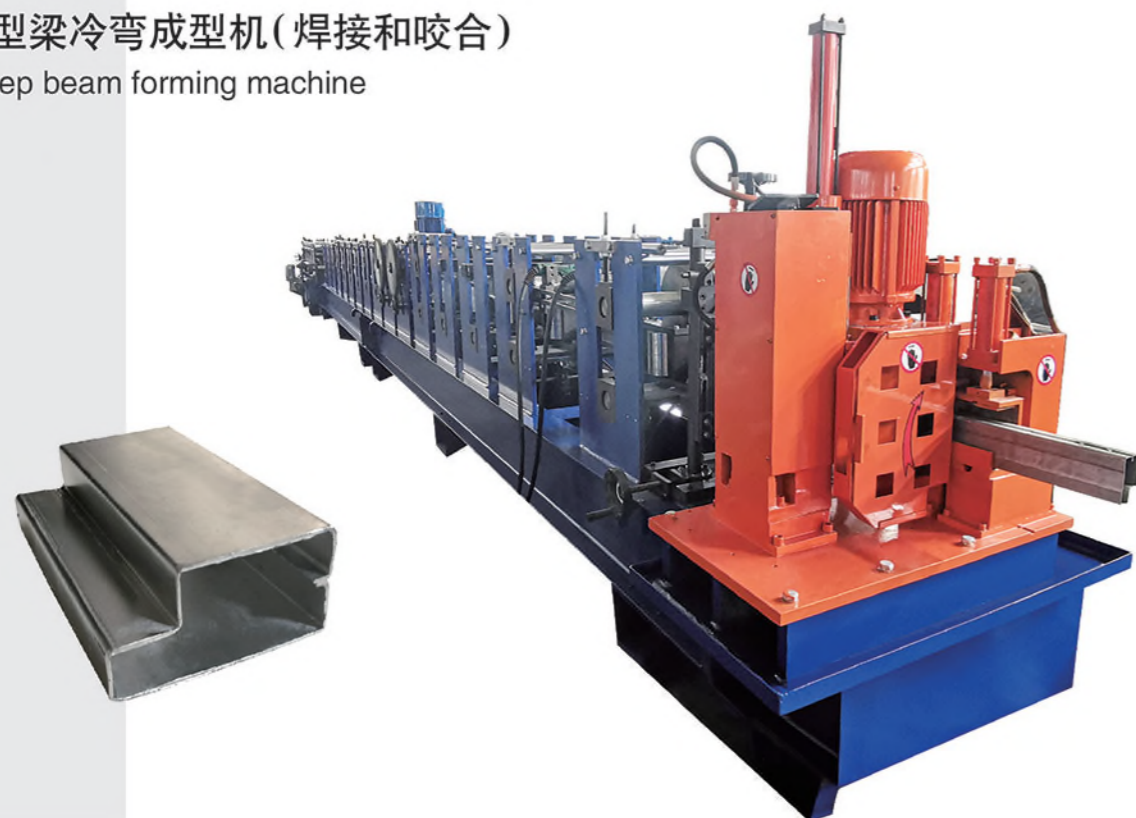

C/Z 互换成型机(跟踪剪切)
C/Z purlin roll forming machine(flying cutting)

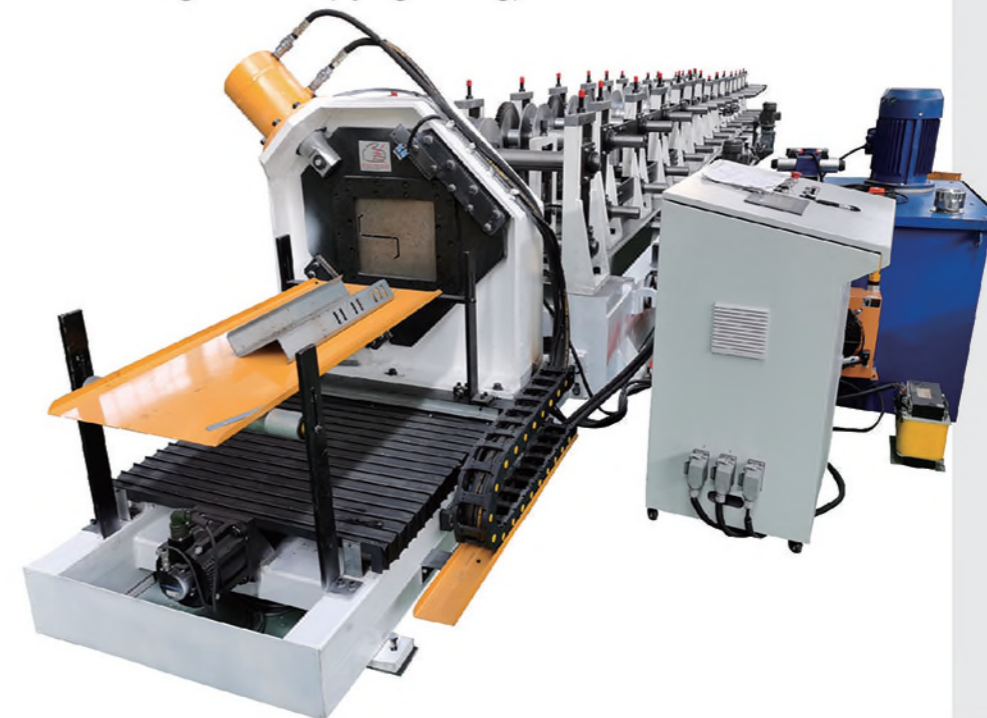

护栏板成型机

Guard rail roll forming machine

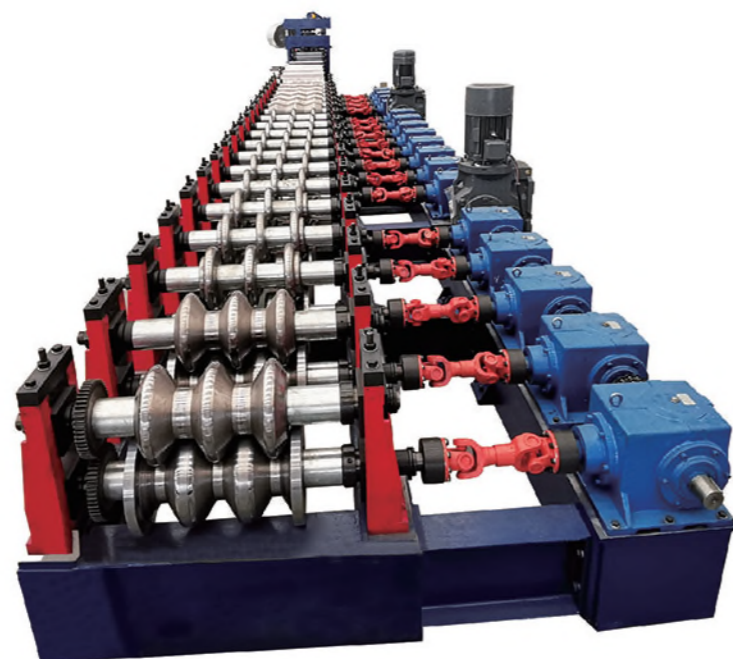

脚踏板成型机

Scaffolding roll forming machine



桃型立柱成型机

Peach post roll forming machine

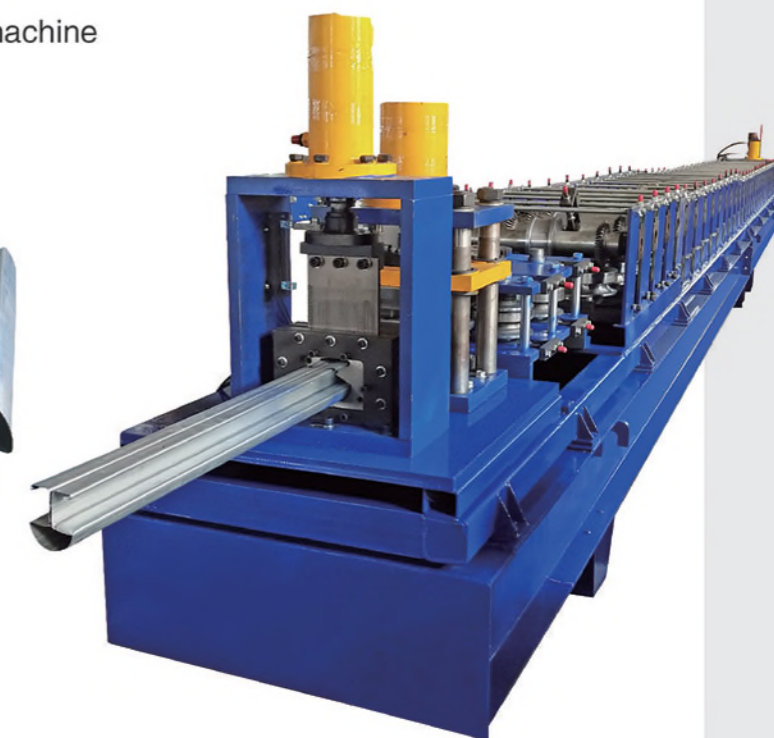
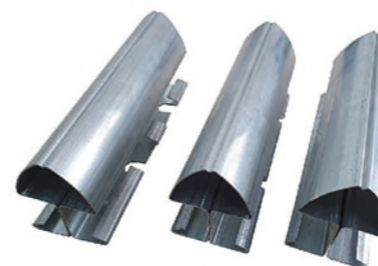

自动码垛 Automatic stack

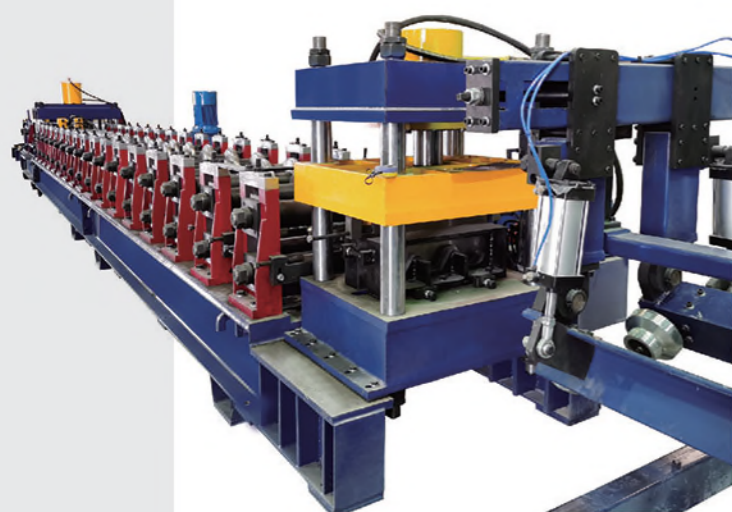

三角支架成型机

Triangular bracket roll forming machine



型钢成型机

Steel roll forming machine



行车KBK轨道

Bridge crane KBK track roll forming machine

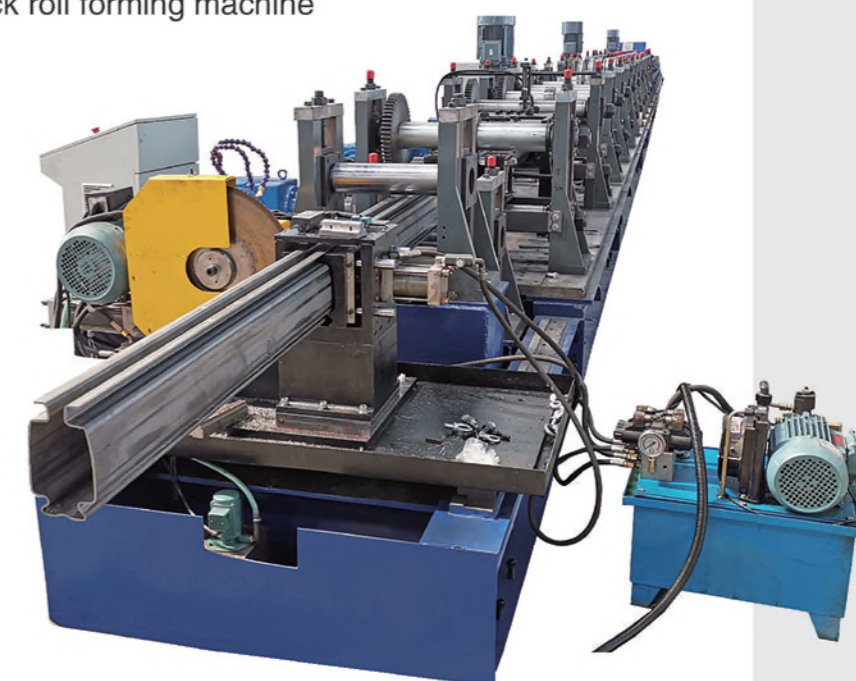

葡萄架成型机

Vineyard post roll forming machine

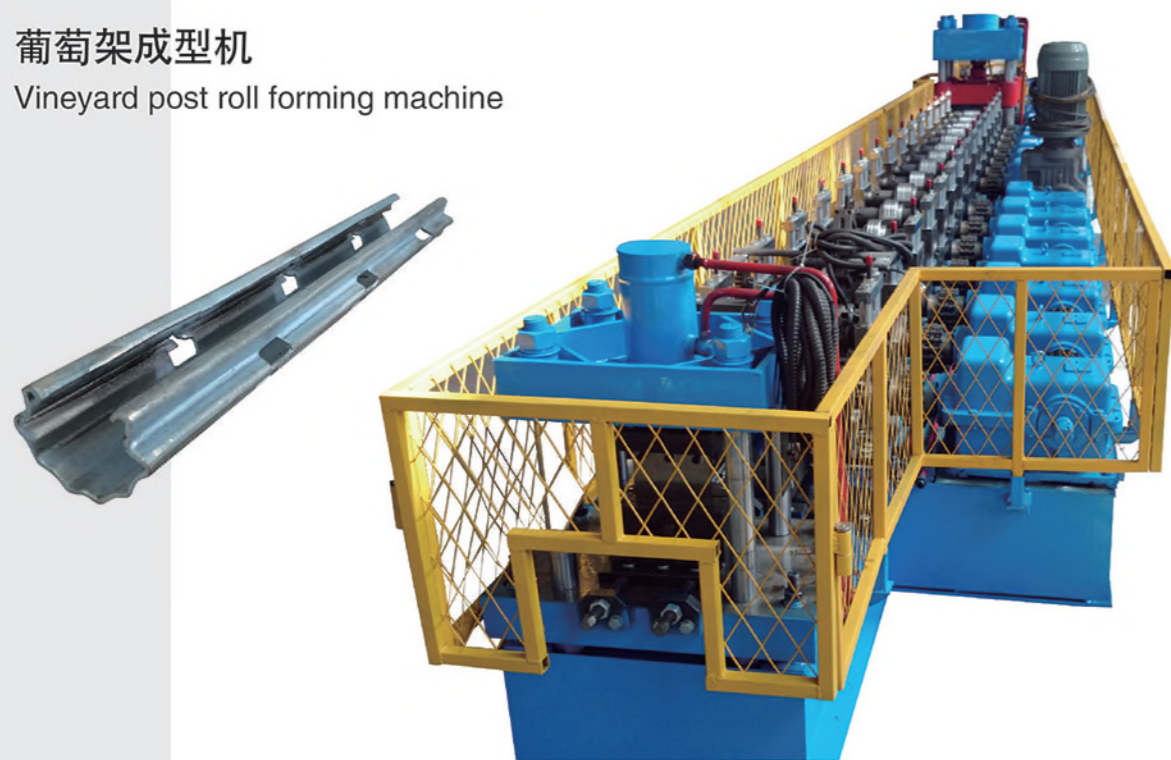

角钢成型机
Angle roll forming machine

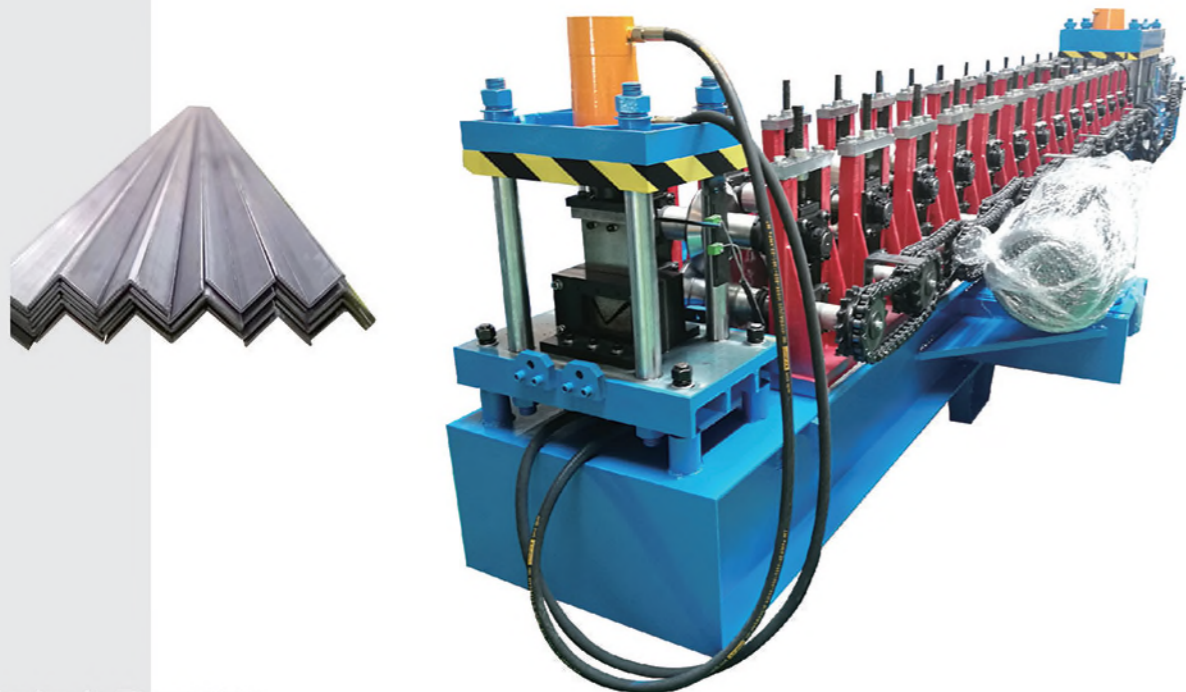

太阳能光伏支架成型机
Solar photovoltaic bracket forming machine



轻钢龙骨压型机
Stud-Track roll forming machine

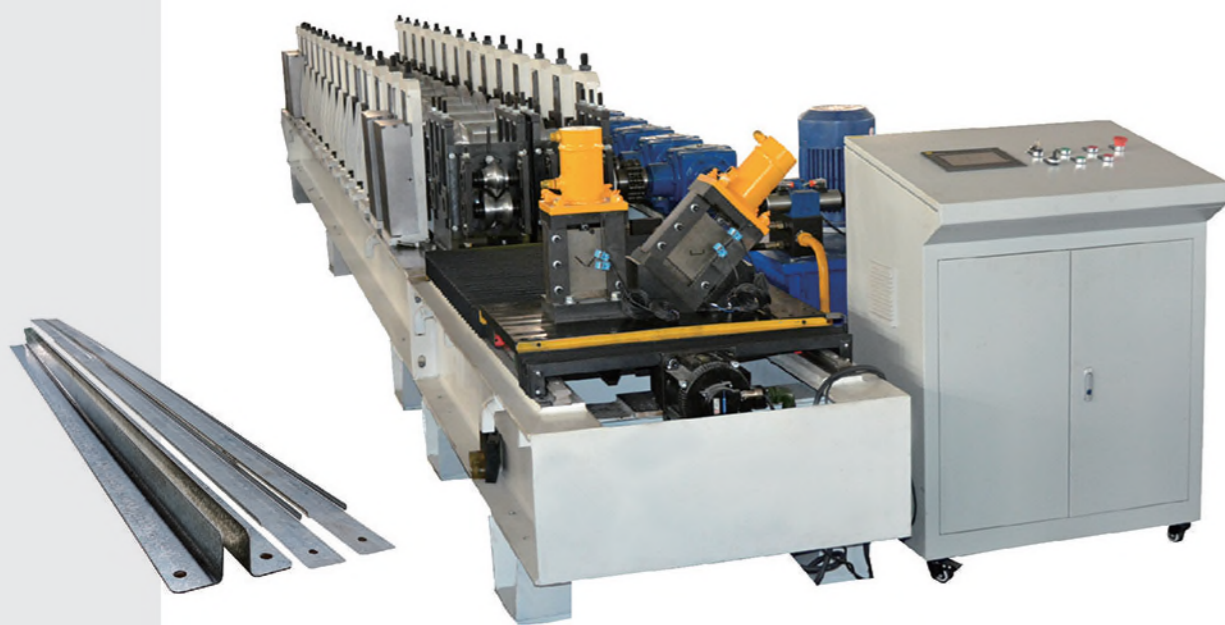

刀片成型机
Blade roll forming machine

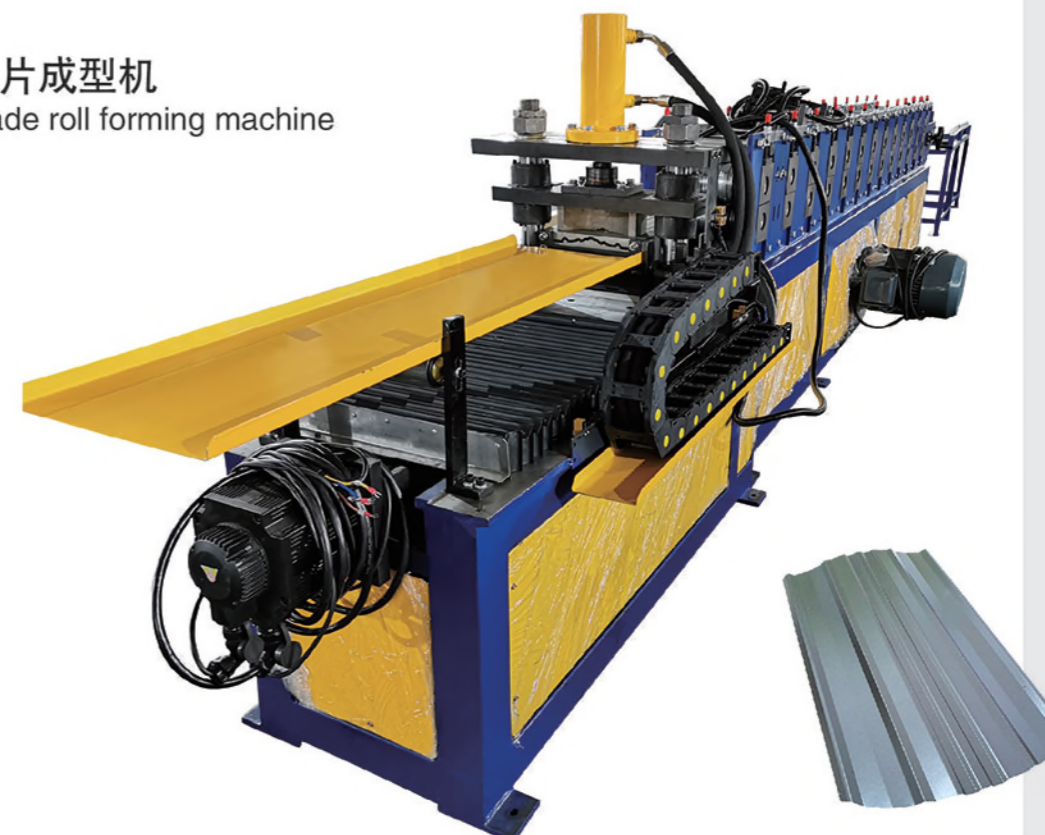

车辆型材系列设备 Vehicle series equipment

澳大利亚房车封板
Australia RV carriage board roll forming machine

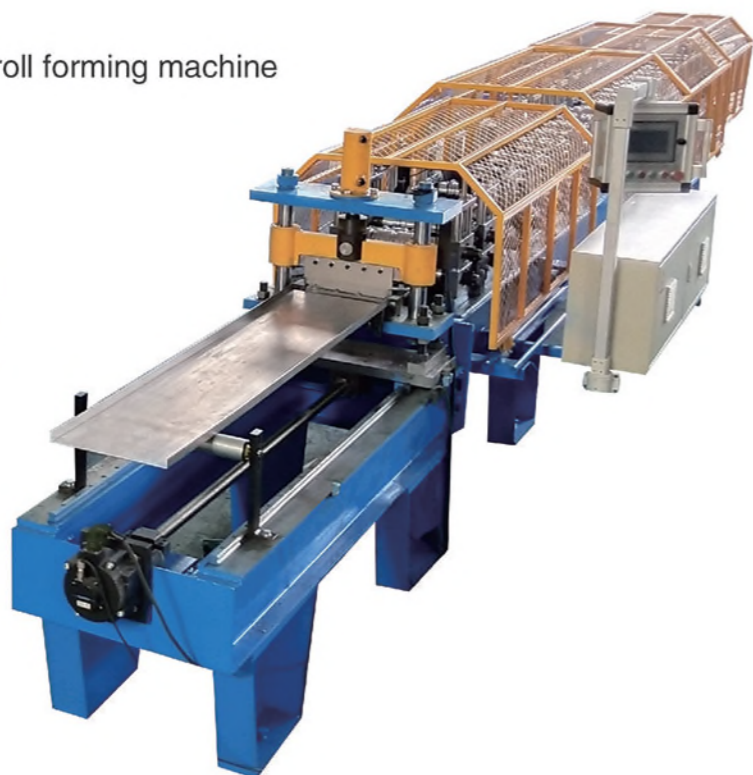

火车车厢板成型机
Train carriage board roll forming machine

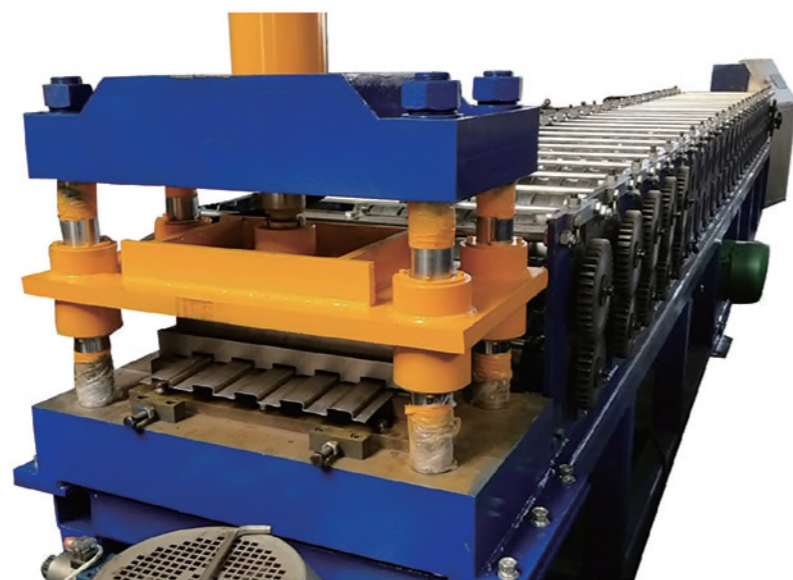

美国通用皮卡底盘加强筋
冷弯成型生产线

U.S.A Universal pickup chassis
stiffener roll forming machine

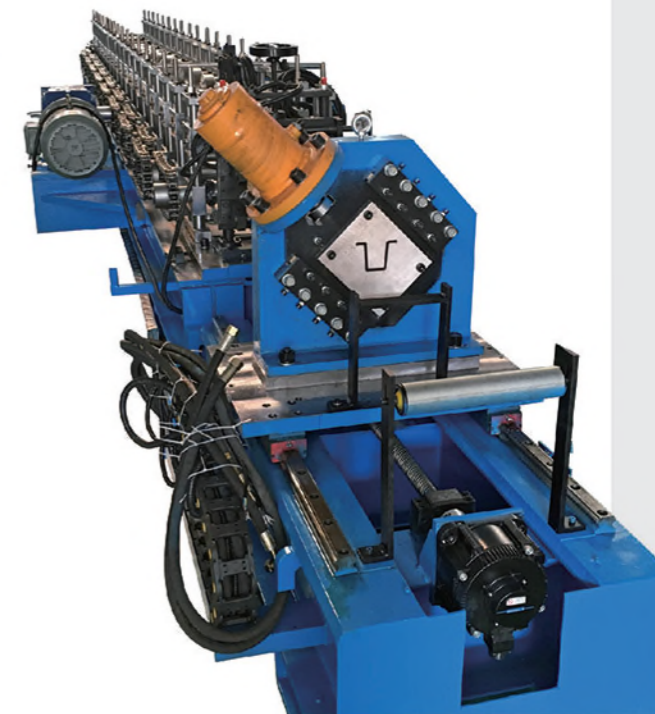

德国宝马玻璃升降器冷弯成型机

German BMW window regulator roll forming machine



电缆桥架系列设备 Cable tray series equipment

核岛桥架

Nuclear island cable tray roll forming machine

Products show

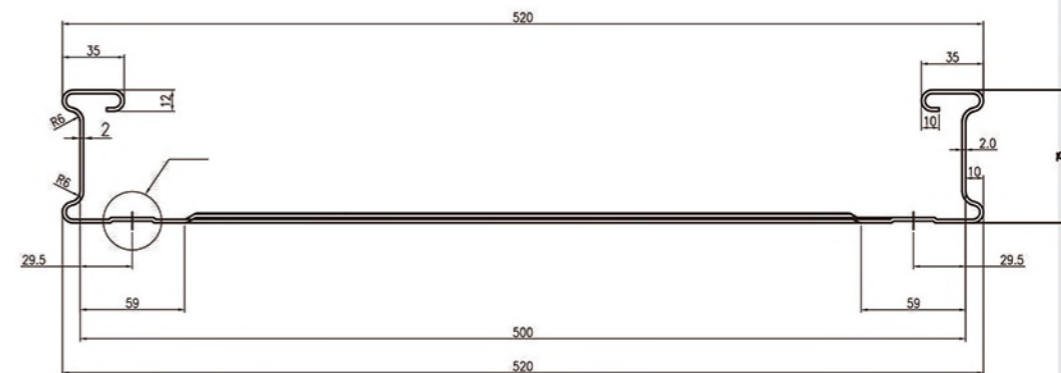
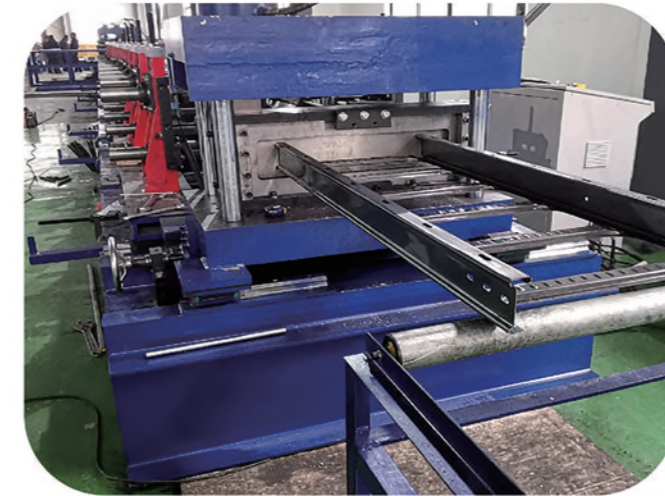
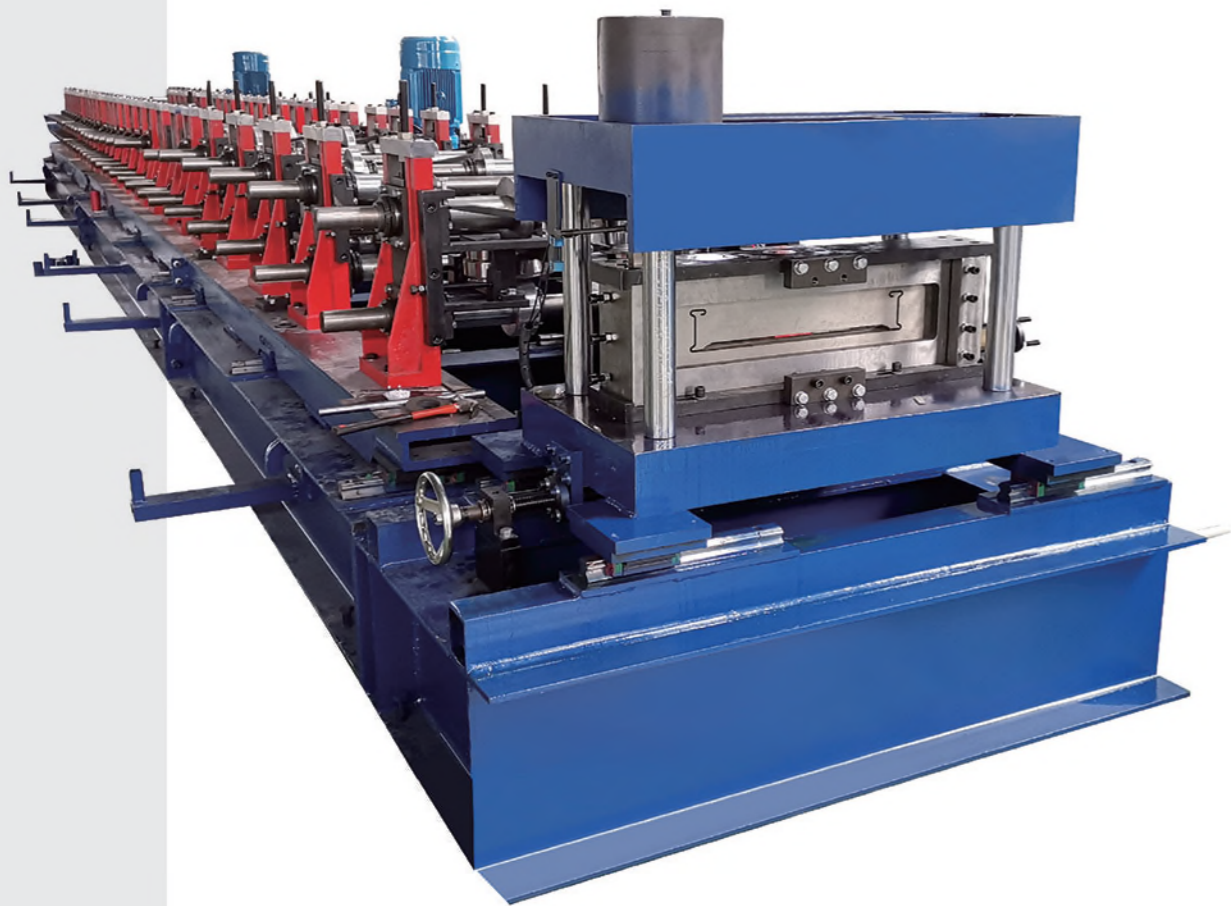

澳洲桥架

Australia cable tray roll forming machine

21

Integrity
Enterprising
Cooperation
Innovation



Products show

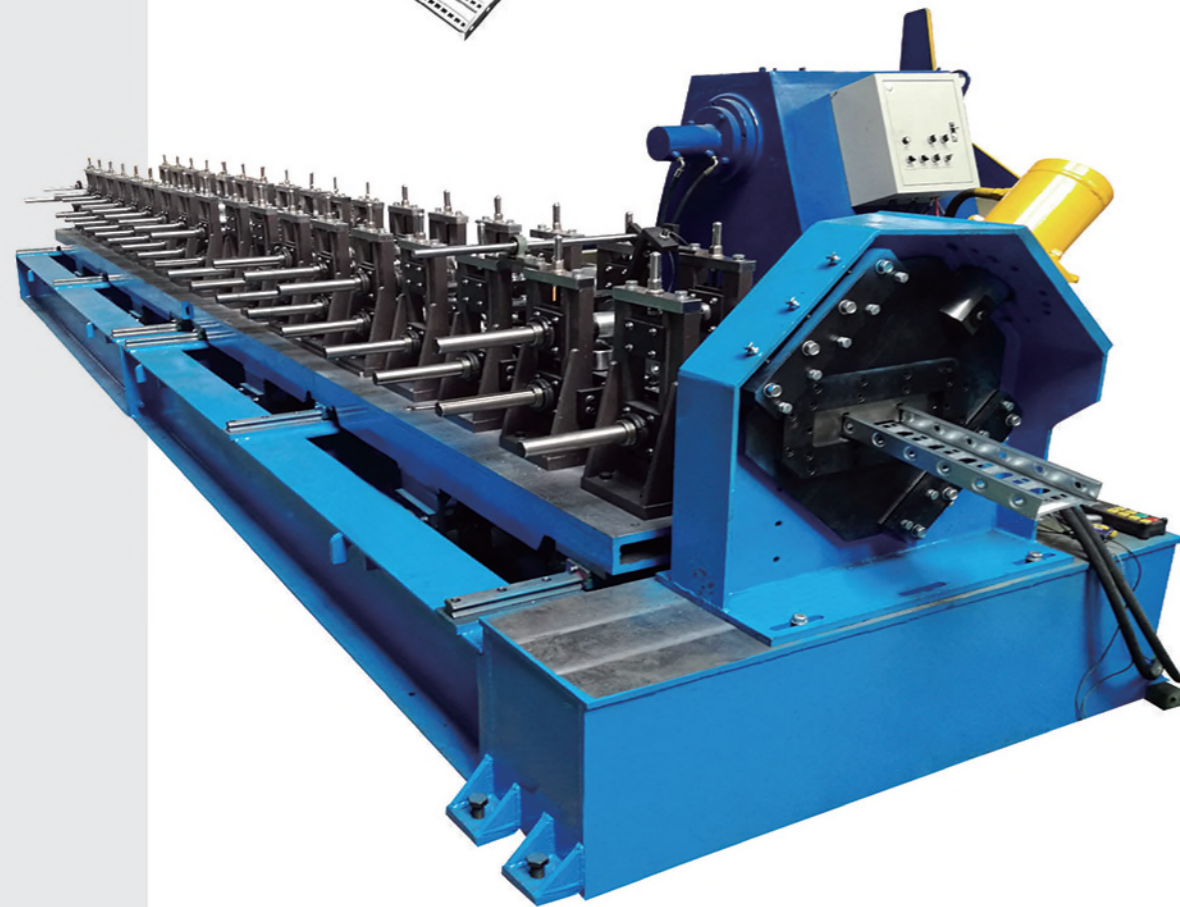

22

Integrity
Enterprising
Cooperation
Innovation

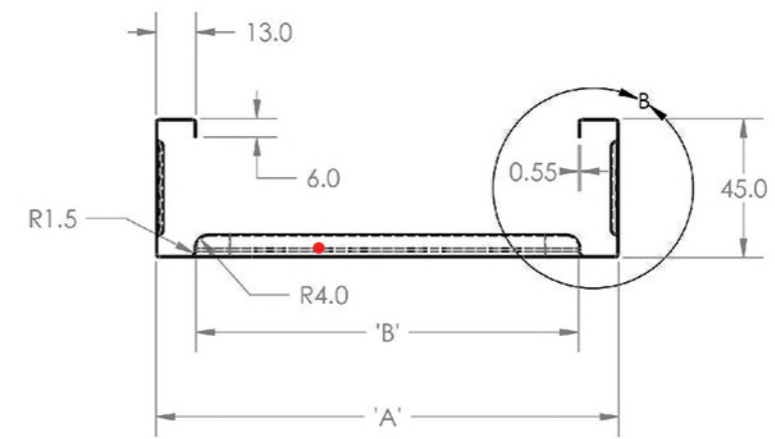

阿根廷桥架

Argentina cable tray roll forming machine



Products show

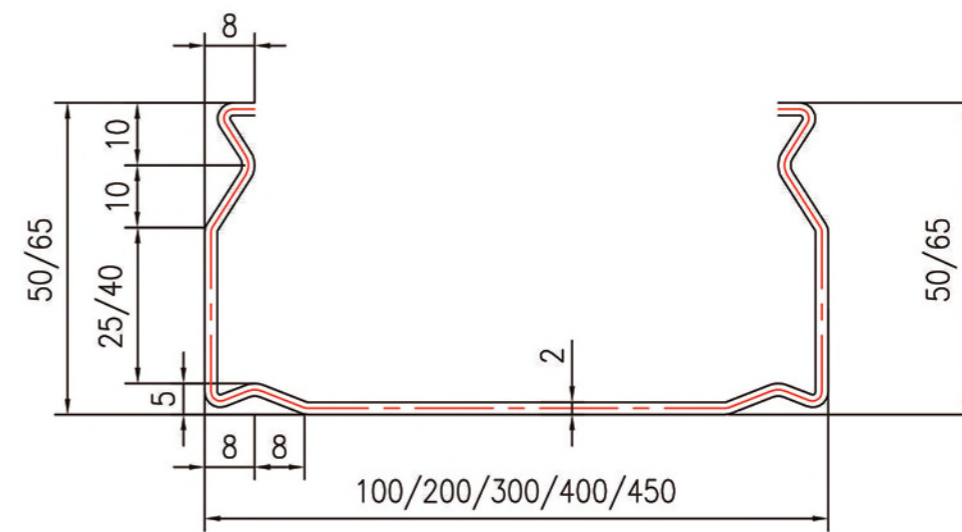
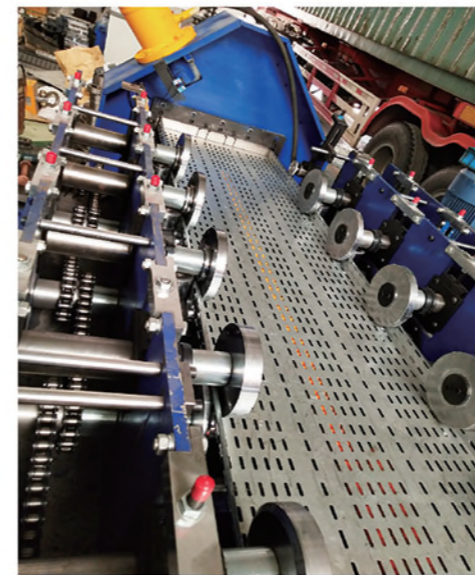
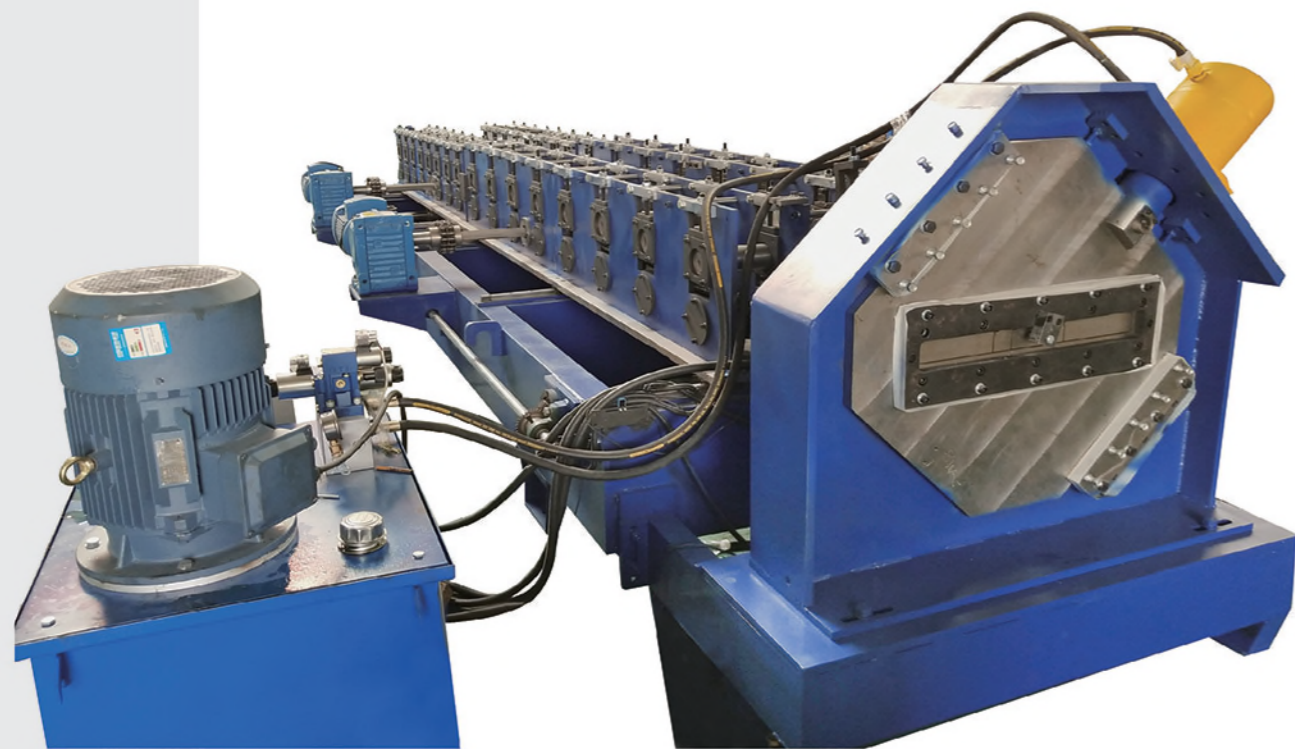

俄罗斯桥架

Russia cable tray roll forming machine

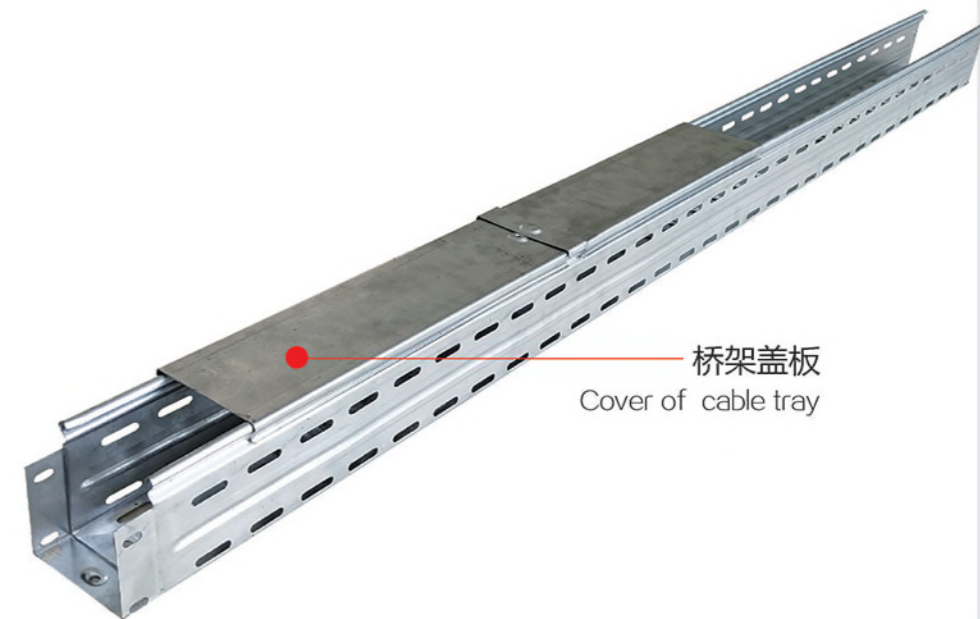
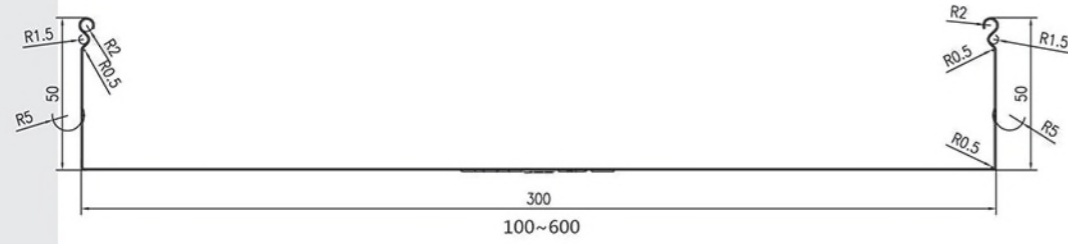
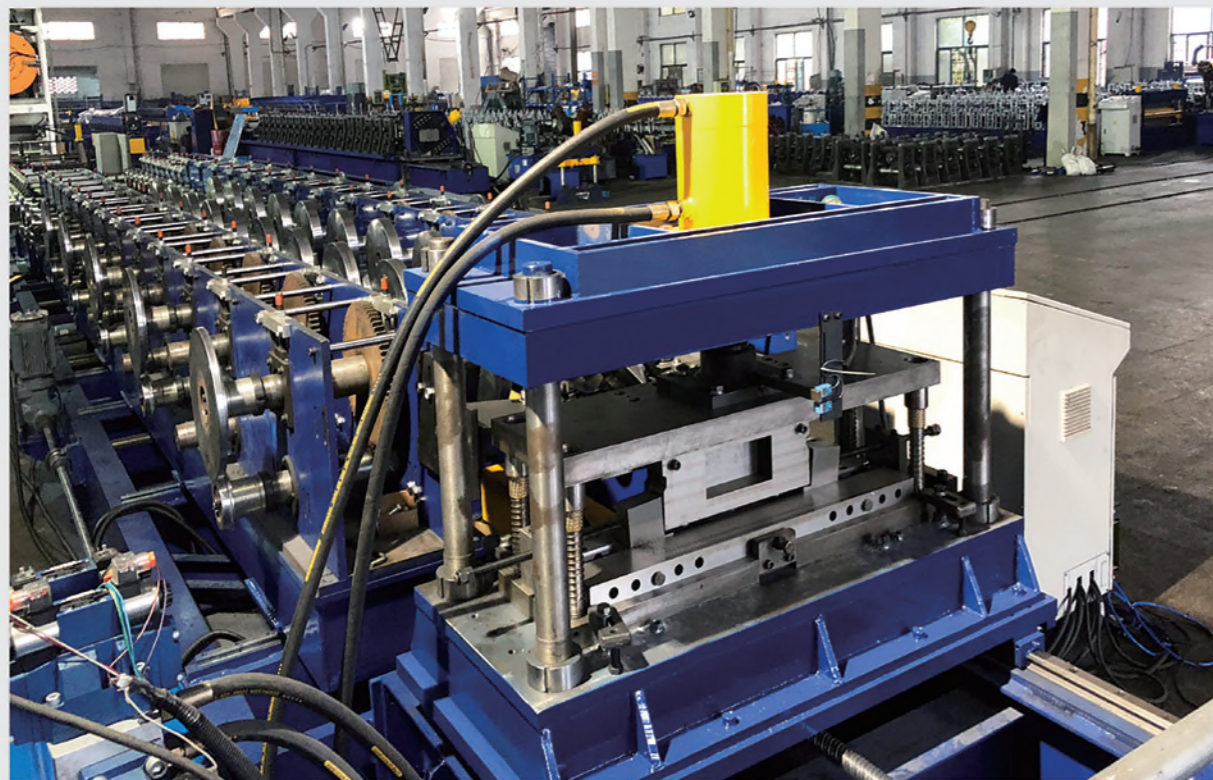

桥架梯边成型机

Cable tray ladder side roll forming machine



桥架横梁成型机

Cable tray beam roll forming machine

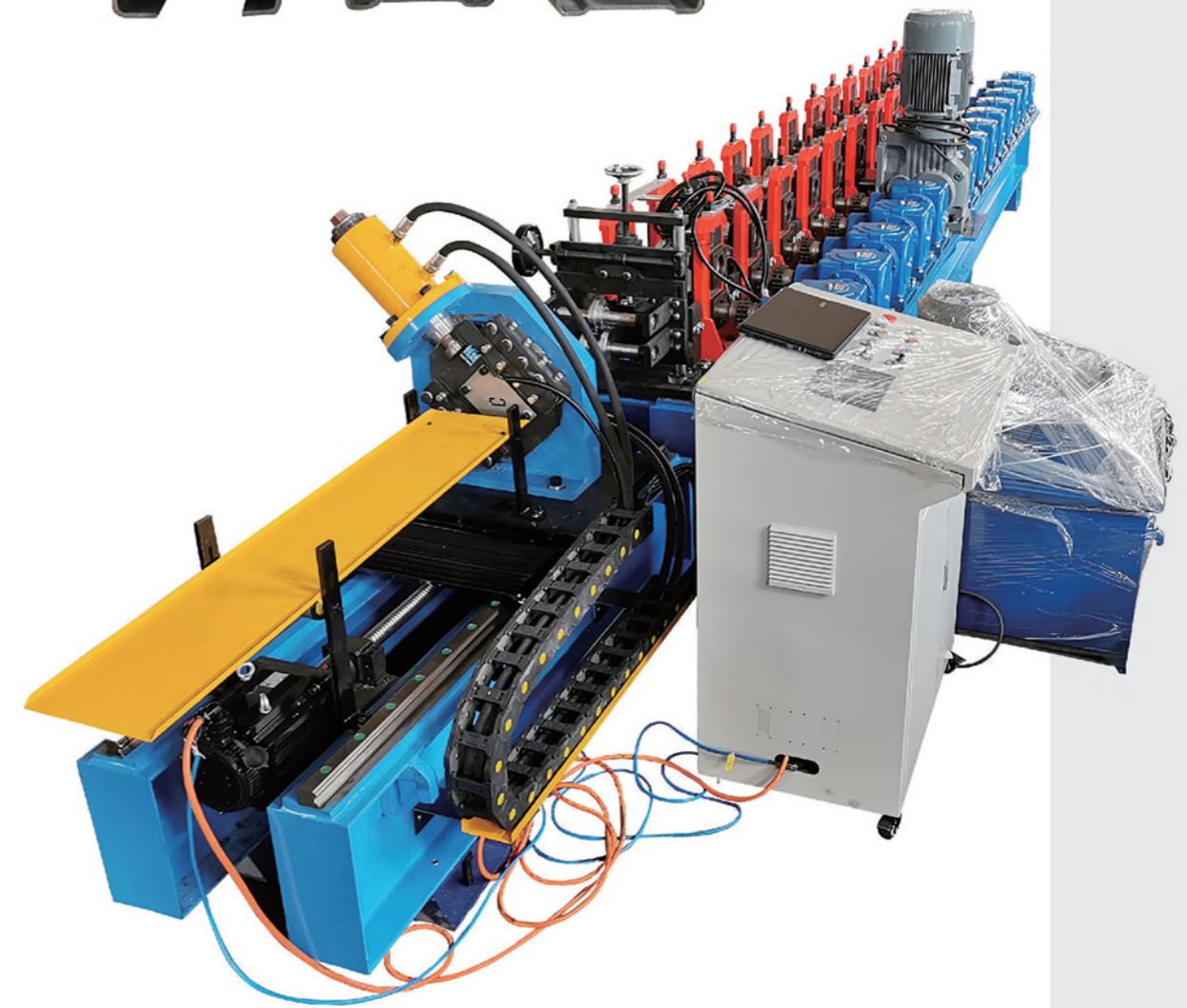
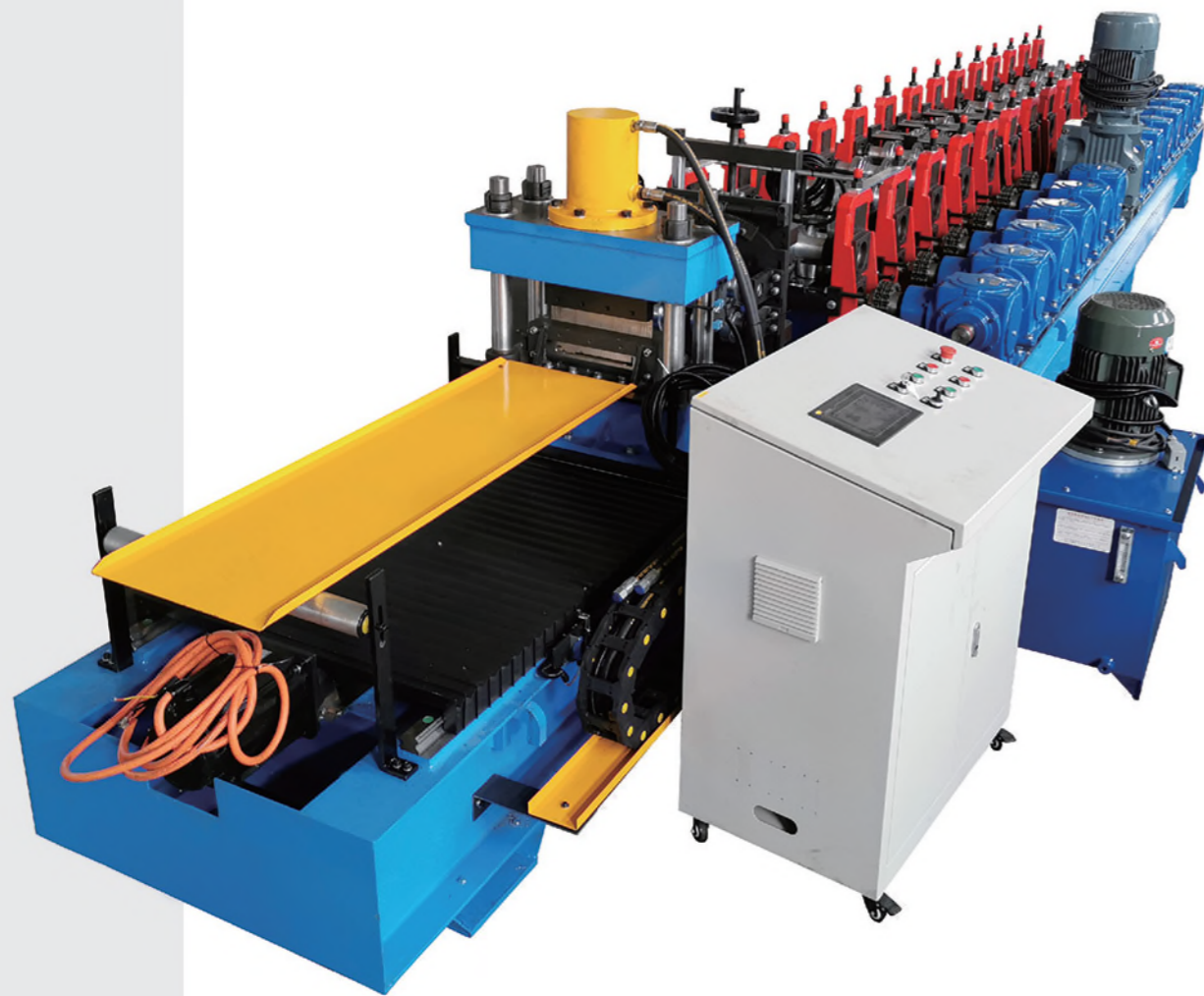

纵横剪系列 Slitting & cutting series equipment

简易纵、横剪生产线
(0.3~1.5mm) Simple slitting & cutting line



高速纵剪生产线 High speed slitting line



产品特点

Product Features

该系列生产线用于将不同规格的卷材沿着长度方向根据需要分成不同宽度的带钢并收卷，产品可以用于轧制，焊管，冷弯成型，冲压成型等材料。

可加工各种冷轧和热轧卷板、硅钢板、不锈钢板、彩板、铝板以及电镀后或涂装后的各类金属板材。

该生产线主要由上料小车、开卷机、引料机，纵剪机、废料收卷机、料头或料尾剪切机、张力控制机及收卷机等设备组成，同时在各机之间还配有摆式中间桥、夹送装置、纠偏装置等。该生产线具有自动化程度高，分条精度高，机器性能稳定可靠，操作维护方便等特点。

The serial lines are used for different sizes coils with different thickness to be slit into special strips as requirements These products are for roll mill ,HF tube mill,cold forming machines ,punching &press machines etc. Raw material is CR material ,HR material , silicon steel, S.S steel Color steel, AL ,PPGI

Composed of coil car-un-coiler-guiding &pinch device-slitter ,side-guiding device-looping-tensioner-scraper-re-coiler -recoil car etc .

主要技术参数

Main Tech Parameter

型号 Type				
可加工板厚(mm) Material Thickness	0.15~1.5	0.15-2.0	0.3-3.0	0.5-4.0
可加工板宽(mm) Material width range	750&1300	1600&1800	1800&2000	200-1600
纵剪条数 Slitting strips	2-20	2-20	2-15	2-15
纵剪条宽度精度(mm) Product precision	±0.1	±0.1	±0.15	±0.15
线速度(mm) Linea speed	10-200 (250)	10-200 (250)	10-150 (200)	10-150 (200)
可开卷重量(T) Coil Weight	10	15	20	25
可开卷内径(mm) ID	Φ508 或Φ610	Φ508 或Φ610	Φ508 或Φ610	Φ508 , Φ610
卷取内径(mm) OD	Φ508	Φ508	Φ508	Φ508
刀轴直径(mm) Blade shaft	Φ205	Φ220	Φ240	Φ240

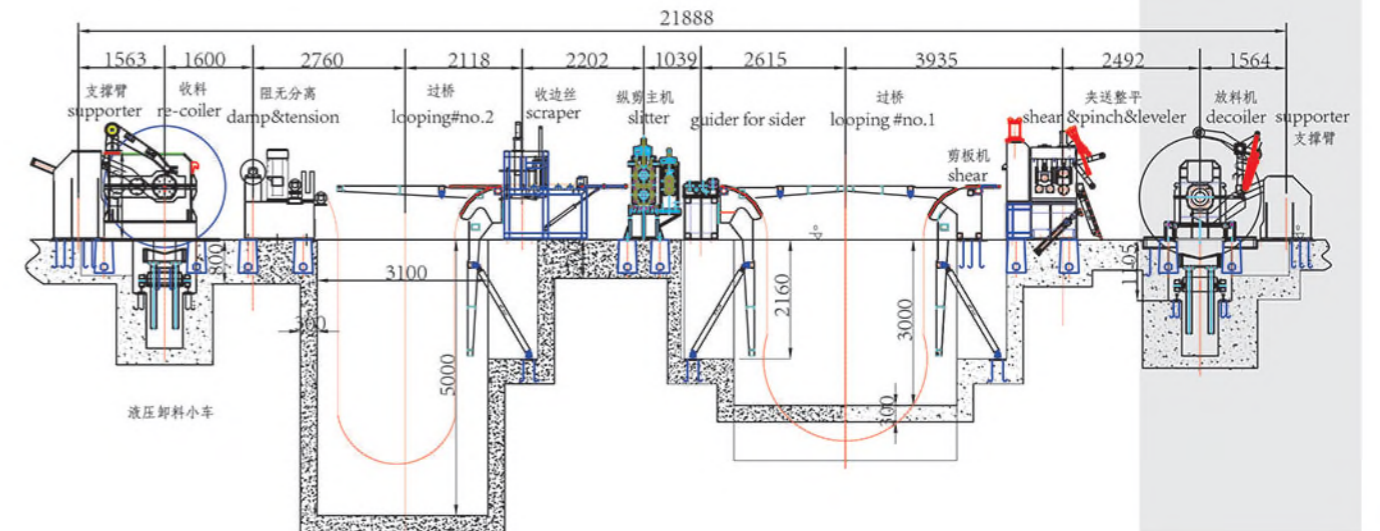

高速横剪生产线 High speed Cut to length line



产品特点

Product Features

该生产线主要由上料小车、开卷机、引料机、纵剪机、废料收卷机、料头或料尾剪切机、张力控制机及收卷机等设备组成，同时在各机之间还配有摆式中间桥、夹送装置、纠偏装置等。该生产线具有自动化程度高，分条精度高，机器性能稳定可靠，操作维护方便等特点。

高速开卷-矫平-横切-堆垛生产线

该系类生产线可加工各种冷轧和热轧卷板、不锈钢、铝板以及电镀后或涂装后的各类金属板材剪切成各种不同规格的定尺板材，并可以附带切边功能。

主要由上料小车、双支撑开卷机、初矫机、精矫机、定尺机、横剪机、堆垛装置、伺服传动系统等组成，同时在各机之间配有摆式中间桥、牵引装置、纠偏装置等。

This production line is used for coil with different specifications, through uncoiling, leveling and cutting to length to flattened plate as needed length and width.

Composed of coil car, double support un-coiler, pre-leveler, finish-leveler, length gauge, cut to length machine, stacker, servo driven system, etc. as well as pendulum middle bridge, pressing and guiding device and steering device.

主要技术参数

Main Tech Parameter

型号 Type				
可加工板厚(mm) Material Thickness	0.11-1.2	0.2-2.0	0.3-3.0	0.5-4.0
可加工板宽(mm) Material width range	200-1300mm	200-1600mm	300-1550&1800mm	300-1600&1800mm
线速度 Linear Speed	0-60m/min	0-60m/min	0-60m/min	0-60m/min
剪切长度范围(mm) Cutting length Range	300-4000	300-4000	300-4000	300-6000
码垛长度范围(mm) Stacking Range	300-4000	300-4000	300-6000	300-6000
剪切长度精度(mm) Cutting length Precision	±0.3	±0.3	±0.5	±0.5
可开卷重量(T) Coil Weight	10&15T	15&20T	20&25T	20&25
矫平辊径(mm) Leveling Diameter	65 (50)	65 (50)	85 (65)	100 (80)

